



LiftAll

PRODUCTS FOR BETTER LIFTING

www.lift-all.com



MANUAL CHAIN HOIST (MCH)

Lift-All hoists are perfect for a low-headroom lift. These economical, durable, and lightweight hoists are excellent options for a variety of lifting applications. The fully enclosed gears are protected from contamination. Powder-coated and plated finishes on exposed components protect the hoists from corrosion. All gears and shafts run on caged roller bearings for smooth operation and long life (excludes mini pullers). The self-adjusting Weston style mechanical load brake never requires adjustment. The top hook mounting aids in rigging and helps ensure straight line loading between hooks.

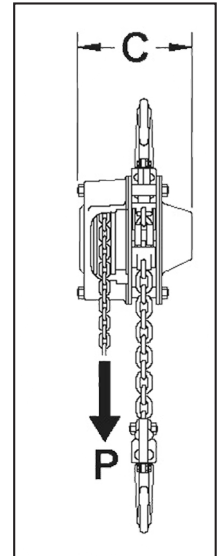
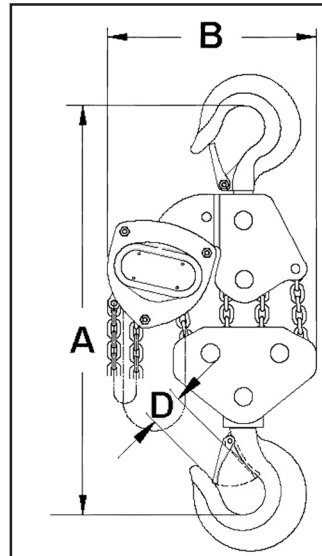

Part Number	Lift	Metric Tons	Load Chain lbs./ft.	Hand Chain lbs./ft.	Dimensions (in./lbs.)					Weight 10' Lift
					A min.	B	C	D	P Effort lbs. @ WLL	
MCH005X10	10'	.5	0.54	0.38	10.6	5.4	5.4	1.10	45	22
MCH005X20	20'									
MCH005X30	30'									
MCH010X10	10'	1	0.54	0.38	13.4	6.4	5.8	1.02	72	26
MCH010X20	20'									
MCH010X30	30'									
MCH015X10	10'	1.5	0.92	0.38	15.7	7.2	6.7	1.28	81	42
MCH015X20	20'									
MCH015X30	30'									
MCH020X10	10'	2	0.92	0.38	16.3	7.6	6.7	1.26	82	44
MCH020X20	20'									
MCH020X30	30'									
MCH030X10	10'	3	1.84	0.38	20.9	8.7	6.7	1.46	87	59
MCH030X20	20'									
MCH030X30	30'									
MCH050X10	10'	5	2.96	0.38	25.0	11.3	7.5	1.80	98	101
MCH050X20	20'									
MCH050X30	30'									
MCH100X10	10'	10	5.92	0.38	29.3	15.1	7.5	1.97	98	183
MCH100X20	20'									
MCH100X30	30'									

Meets ASME B30, OSHA 1915.114, and NASA-STD-8719.9

*** WARNING**

- Do not exceed working load limit (load rating capacity).
- Do not lift loads over people.
- Do not use to lift people.

- Use only alloy chain for overhead lifting.
- Read and follow all instructions.

LEVER CHAIN HOIST (LCH)

Lever Chain Hoists are highly versatile tools that can be used to pull, lift, drag or stretch. All Lever Chain Hoists use alloy steel chain for long life, and forged steel swivel hooks with latches for safety.

Part Number	Lift	WLL (Metric Ton)
LCH008X5	5'	3/4
LCH008X10	10'	
LCH008X20	20'	
LCH015X5	5'	1.5
LCH015X10	10'	
LCH015X20	20'	
LCH030X5	5'	3
LCH030X10	10'	
LCH030X20	20'	
LCH060X5	5'	6
LCH060X10	10'	
LCH060X20	20'	

- Easy one hand operation and setup.
- Operates in any orientation.
- Non-slip rubber grip lever and 360° rotation require minimal space for operation with 20 to 30% less pull force than other brands.
- Powder-coated and plated finishes resist corrosion.
- Fully enclosed gearing to protect from contamination.
- The automatic Weston style mechanical load brake will react to the inertia of a descending load.
- Drop forged alloy hooks are designed to stretch before chain failure when overloaded and are equipped with cast steel safety latches.
- The top hook articulates to aid in rigging and helps ensure straight line loading between hooks.

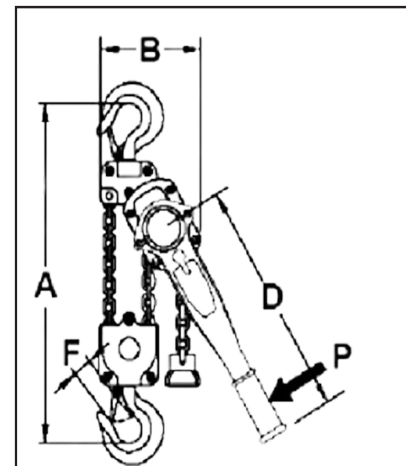
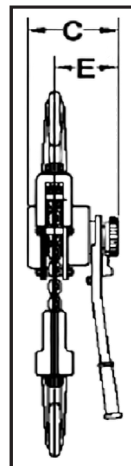

Part Number	Dimensions (in.)						P Effort lbs. @ WLL	Weight per foot (lbs.)	Weight (lbs.) A=5-ft.
	A	B	C	D	E	F			
LCH008	12.6	5.3	5.8	11.4	3.5	0.94	31	0.54	17
LCH015	15.0	6.4	6.9	16.5	4.0	1.14	54	0.92	26
LCH030	18.9	8.3	7.7	16.5	4.3	1.42	72	1.48	46
LCH060	24.4	10.0	7.7	16.5	4.3	1.81	76	2.96	70

Meets ASME B30, OSHA 1915.114, and NASA-STD-8719.9

*

WARNING

- Do not exceed working load limit (load rating capacity).
- Do not lift loads over people.
- Do not use to lift people.

- Use only alloy chain for overhead lifting.
- Read and follow all instructions.

MINI LEVER HOISTS (MLH)

Mini Lever Hoists can lift up to 1,100 lbs., yet are small enough to fit in your toolbox! These mini lever hoists are the most compact on the market. They perform just like the larger models, plus come with these great features:

- Easy to transport, install, and store.
- Low headroom design for use in tight spaces.
- Rubber hand grip for better comfort and security.
- Lightweight and durable all-steel construction with chrome exterior finish to resist corrosion.
- Sleeve bearings maximize serviceability and provide good efficiency.
- Self-adjusting pawl and disc type mechanical load brake ensure positive load control.
- The brake will stop a load even if the operator leaves the unit in free chain mode and in neutral.
- Your choice of either 5-ft. or 10-ft. lifts.
- Meets ASME B30, OSHA 1915.114, and NASA-STD-8719.9

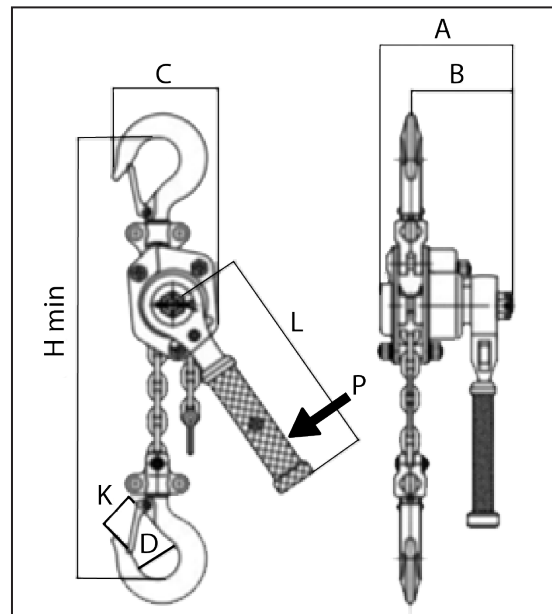

Part Number	Lift (ft.)	WLL (lbs.)	Dimensions (in.)							P Effort lbs. @ WLL	Weight (lbs.)
			A	B	C	D	H min	L	K		
MLH003X5	5	550	3.6	2.8	3.3	1.2	9.8	6.3	0.9	56.2	4.4
MLH003X10	10										
MLH005X5	5	1100	4.1	3.1	3.1	1.4	10.2	11.8	1.1	40	7.7
MLH005X10	10										

*

WARNING

- Do not exceed working load limit (load rating capacity).
- Do not lift loads over people.
- Do not use to lift people.

- Use only alloy chain for overhead lifting.
- Read and follow all instructions.

PUSH TROLLEY

- 1/2t to 5t installation and adjustment by rotating the threaded hanger shaft.
- 10t to 30t is from one side, trolley hanger shafts are mounted to the opposite side plate.
- Trolleys up to 5t have a 5:1 design factor and can be used for manual or powered hoists.
- The 10t has a 4:1 design factor and must be derated for powered hoist.
- Machined cast iron wheels with universal tread design to fit flat on tapered beam flanges.
- Low headroom design with precision sealed "lubed for life" bearings assure smooth operation.
- Durable all steel construction with standard safety lugs.
- Geared trolley hand chain drop is standard with a 20' drop.
- Meets ASME/ANSI B30.16, OSHA, NASA-STD-8719.9, EU Directives: 2006/42/EC.
- ATEX rated Ex II 3 GD c IIB 54° C X for limited use in Hazardous Environments.

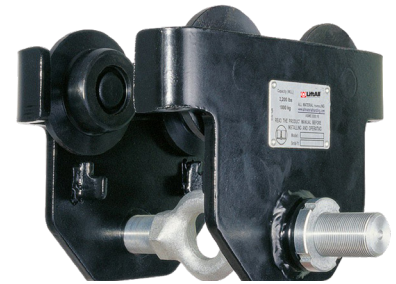

Model	WLL (Metric Tons)	A	B	C Standard (in.)	Dimensions (in.)											R MIN (in.)	Weight (lbs.)
					D	E	F	G	H	I	J	K	L	M	P		
PT005	1/2	3.3	11.5	1.97 - 8.66	0 - 0.12	1.5	2.3	3.4	1.2	0.9	8.9	6.8	—	4	—	36	18
PT010	1	3.7	11.8	2.28 - 8.66	0 - 0.12	1.7	2.4	3.7	1.4	0.9	9.9	7.4	—	4.7	—	40	24
PT020	2	4.4	12.2	2.60 - 8.66	0 - 0.12	1.6	3.2	4.6	1.9	1.0	11.8	8.9	—	5.5	—	48	40
PT030	3	5.8	12.8	2.91 - 8.66	0 - 0.12	2.5	3.9	5.5	2.3	1.3	14.2	11.4	—	6.3	—	52	69
PT050	5	6.3	13.0	3.54 - 8.66	0 - 0.12	2.2	4.3	5.9	2.8	1.5	15.4	12.3	—	6.7	—	56	94
PT100	10	7.5	15.5	4.9 - 12.01	0.08 - 0.13	1.8	7.0	5.4	4.4	2.8	18.1	15.5	1.8	7.9	—	79	198

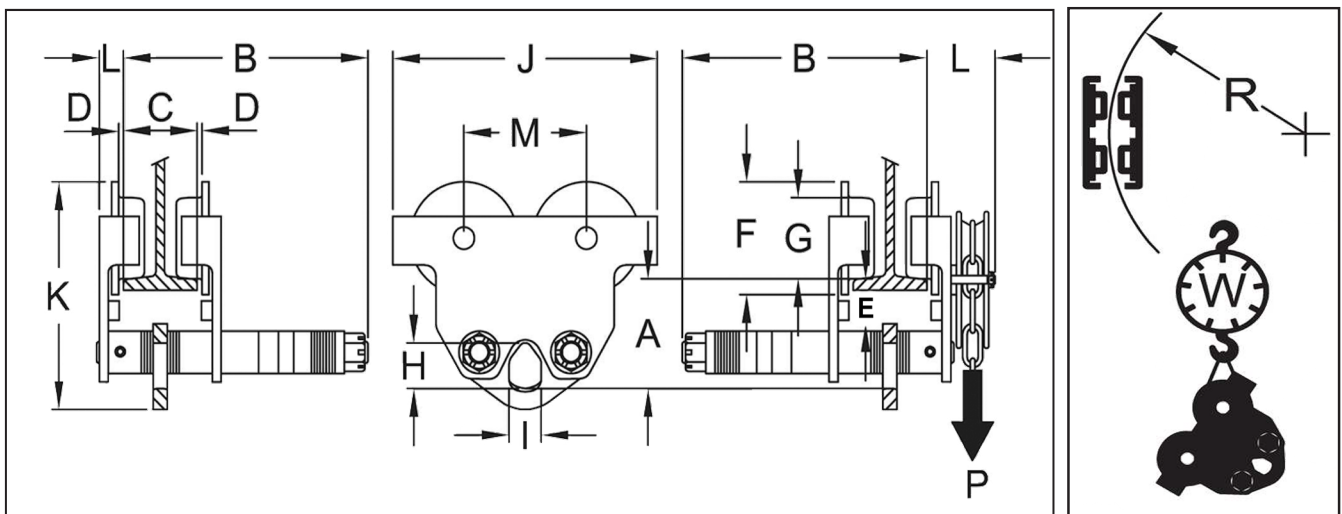

BEAM CLAMP

- The easy way to install a fixed hoist mount or rigging point.
- Simple installation by hand, no tools required.
- Compact and portable low headroom design.
- Meets OSHA, ASME B30, NASA-STD-8719.9 and EU Directives: 2006/42/EC.



Model	WLL (Metric Tons)	WLL Capacity from Vertical				Dimensions (in.)							Weight (lbs.)
		0°	15°	30°	45°	A Adjustment	B Max	C	D	E	F Max	H	
BC-10	1	2,200	0	0	0	3.1 - 9.6	14.6	3.7	0.75	7.8	5.6	0.8	7.7
BC-20	2	4,400	0	0	0	3.1 - 9.6	14.6	4.0	0.75	7.8	5.6	0.8	9.9
BC-30	3	6,600	0	0	0	3.5 - 13.0	19.7	5.2	1.12	10.4	7.8	0.9	20.9
BC-50	5	11,000	0	0	0	3.5 - 13.0	19.7	5.6	1.41	10.4	8.2	0.9	24.3
BC-100	10	22,000	0	0	0	3.5 - 13.0	20.6	7.1	1.50	11.2	8.4	1.5	35.2

